

The background of the entire page is a photograph of a worker inside a large metal container. The worker is wearing a yellow hard hat, a green high-visibility vest over an orange long-sleeved shirt, and dark pants. They are standing with their arms outstretched, touching the inner walls of the container. The container's interior is made of corrugated metal, and the floor is a metal grating. The lighting is bright, coming from the open doors at the end of the container, creating a silhouette effect on the worker.

CONTAINER EQUIPMENT: OUR INTERMODAL SERVICE

We use our own containers to deliver cargo between Europe, CIS, China and the Far East. We are also active in container trading and providing containers on a one-way lease.

CONTENT

1. OUR CONTAINERS – YOUR ADVANTAGE
2. CONTAINER TRADING
3. ONE-WAY LEASE
4. DRY FREIGHT CONTAINER
5. HIGH CUBE CONTAINER
6. OPEN TOP CONTAINER
7. FLAT RACK
8. PLATFORM
9. REFRIGERATED CONTAINER
10. HIGH CUBE REFR. CONT.
11. TANK CONTAINER
12. CONTACT



1. OUR CONTAINERS – YOUR ADVANTAGE

We can supply you with the right equipment to deliver your cargo in a safe and secure manner by sea (short sea and deep sea), rail or using intermodal solutions. We have own containers available in various strategic areas in Europe, Turkey, CIS, China and Asia. In addition, we buy and sell new and used containers, relocate them to key positions (when required) and provide containers on a one-way lease.



2. CONTAINER TRADING

WE PROVIDE CONTAINERS AND SPECIALISED EQUIPMENT

We buy and sell new and used containers for storage, temporary leasing or one-way transport to almost any destination in the world. We constantly hold stocks of mainly standard types of containers (20'DC, 40'DC, 40'HC) in the most strategic points in Europe, CIS, Turkey, China and Asia. Specialised equipment can be sourced upon request. This means we are ready to supply you with the necessary equipment when and where required.



3. ONE-WAY LEASE

Container Cabotage

We offer relocation of our containers in a one-way lease or cabotage movement. Usually, this is done between areas where there is an imbalance between demand and supply. A period of free time is offered to complete the movement with a competitive rental fee afterwards. An additional fee might apply, depending on your preferred or requested pick-up or drop-off location.



4. DRY FREIGHT CONTAINER

General purpose container

- /// Ideal for shipping or ground storage
- /// Suitable for any general cargo

20' CONTAINER

Exterior:

Length: 20'
Width: 8'
Height: 8'6"

Interior:

Length: 19'6"
Width: 7'8"
Height: 7'10"

Door opening:

Width: 7'8"
Height: 7'6"

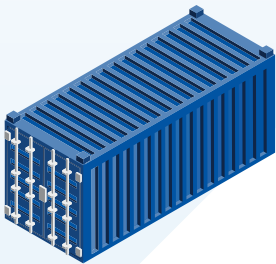

40' CONTAINER

Exterior:

Length: 40'
Width: 8'
Height: 8'6"

Interior:

Length: 39'7"
Width: 7'8"
Height: 7'10"

Door opening:

Width: 7'8"
Height: 7'6"

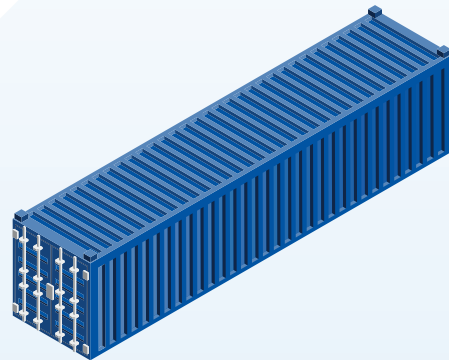

4. DRY FREIGHT CONTAINER

General purpose container

- /// Ideal for shipping or ground storage
- /// Suitable for any general cargo

TRIED AND TRUE BENEFITS

- Own equipment, including 20'DC, 40'DC, 40'HC, 40'PWHC, 45'PWHC, 20'OT, 40'OT, 20'FR, 40'FR
- Own containers available at various strategic locations
- Extensive network of depot facilities
- Broad knowledge and solid experience in one-way movements
- Ability to offer the right equipment depending on route, transport mode, cargo specifics and local regulations
- Possibility to create stocks (for projects)
- Competitive conditions for demurrage / detention
- Competitive slot agreements on feeder services

EXCELLENCE IN PERFORMANCE

- Cooperation with preferred and verified subcontractors
- Containers are delivered with valid CSC plate certification
- Containers are checked to ensure safe transportation by sea, rail or truck
- Possibility to arrange quick release of container equipment

RELIABLE SCHEDULES AND DELIVERY TIMES

Rhenus has an extensive network of depot facilities at all the main ports and other strategic locations in Europe, CIS, Turkey, China and Asia. This way, we guarantee on-time delivery to any given location.

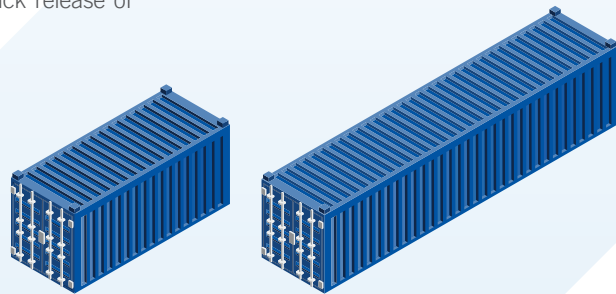

5. HIGH CUBE CONTAINER

For overheight and light, voluminous cargo or ground storage.

40' CONTAINER

Exterior:

Length: 40'
Width: 8'
Height: 9'6"

Interior:

Length: 39'7"
Width: 7'8"
Height: 8'9"

Door opening:

Width: 7'8"
Height: 8'6"
Height: 7'6"

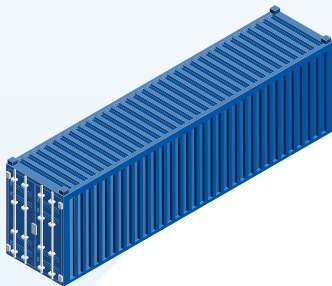

45' CONTAINER

Exterior:

Length: 40'
Width: 8'
Height: 9'6"

Interior:

Length: 44'7"
Width: 7'8"
Height: 7'8"

Door opening:

Width: 7'8"
Height: 8'6"

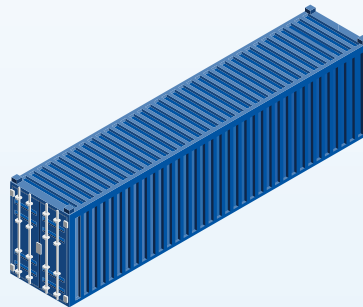

5. HIGH CUBE CONTAINER

For overheight and light, voluminous cargo or ground storage.

TRIED AND TRUE BENEFITS

- Own equipment, including 20'DC, 40'DC, 40'HC, 40'PWHC, 45'PWHC, 20'OT, 40'OT, 20'FR, 40'FR
- Own containers available at various strategic locations
- Extensive network of depot facilities
- Broad knowledge and solid experience in one-way movements
- Ability to offer the right equipment depending on route, transport mode, cargo specifics and local regulations
- Possibility to create stocks (for projects)
- Competitive conditions for demurrage / detention
- Competitive slot agreements on feeder services

EXCELLENCE IN PERFORMANCE

- Cooperation with preferred and verified subcontractors
- Containers are delivered with valid CSC plate certification
- Containers are checked to ensure safe transportation by sea, rail or truck
- Possibility to arrange quick release of container equipment

RELIABLE SCHEDULES AND DELIVERY TIMES

Rhenus has an extensive network of depot facilities at all the main ports and other strategic locations in Europe, CIS, Turkey, China and Asia. This way, we guarantee on-time delivery to any given location.

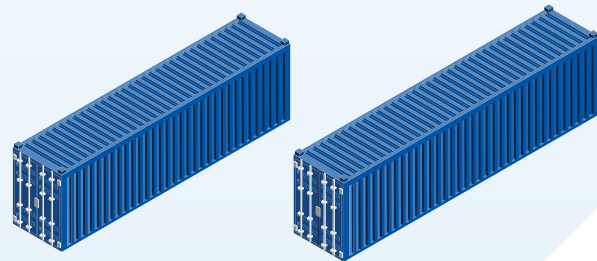

6. OPEN TOP CONTAINER

Removable tarpaulin for top loading of oversized cargo.



20' CONTAINER

Exterior:

Length: 20'

Width: 8'

Height: 8'6"

Interior:

Length: 19'6"

Width: 7'8"

Height: 7'8"

Door opening:

Width: 7'8"

Height: 8'6"

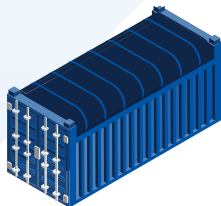

- /// Overheight cargo
- /// Loading from top side (cranes)
- /// Loading from door side (cargo hanging from overhead tackle)

40' CONTAINER

Exterior:

Length: 40'

Width: 8'

Height: 8'6"

Interior:

Length: 39'6"

Width: 7'8"

Height: 7'8"

Door opening:

Width: 7'8"

Height: 8'6"

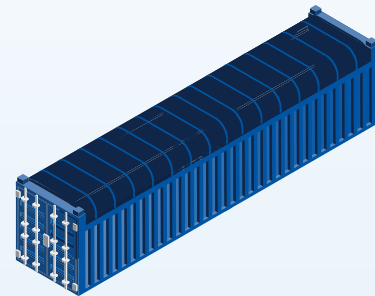

6. OPEN TOP CONTAINER

Removable tarpaulin for top loading of oversized cargo.

TRIED AND TRUE BENEFITS

- Own equipment, including 20'DC, 40'DC, 40'HC, 40'PWHC, 45'PWHC, 20'OT, 40'OT, 20'FR, 40'FR
- Own containers available at various strategic locations
- Extensive network of depot facilities
- Broad knowledge and solid experience in one-way movements
- Ability to offer the right equipment depending on route, transport mode, cargo specifics and local regulations
- Possibility to create stocks (for projects)
- Competitive conditions for demurrage / detention
- Competitive slot agreements on feeder services

EXCELLENCE IN PERFORMANCE

- Cooperation with preferred and verified subcontractors
- Containers are delivered with valid CSC plate certification
- Containers are checked to ensure safe transportation by sea, rail or truck
- Possibility to arrange quick release of container equipment

RELIABLE SCHEDULES AND DELIVERY TIMES

Rhenus has an extensive network of depot facilities at all the main ports and other strategic locations in Europe, CIS, Turkey, China and Asia. This way, we guarantee on-time delivery to any given location.

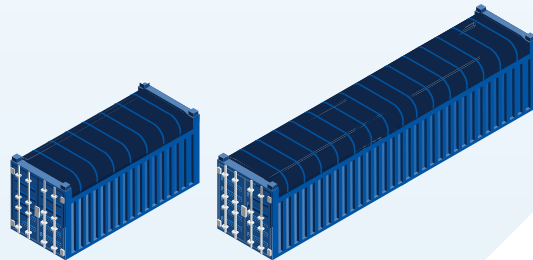

7. FLAT RACK

For transportation of over-width and heavy cargo.

20' CONTAINER

Exterior:

Length: 20'

Width: 8'

Height: 8'6"

Interior:

Length: 19'6"

Width: 7'8"

Height: 7'10"

Door opening:

Width: 7'8"

Height: 7'6"

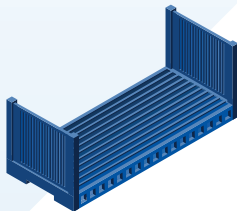

40' CONTAINER

Exterior:

Length: 40'

Width: 8'

Height: 8'6"

Interior:

Length: 39'7"

Width: 7'8"

Height: 7'10"

Door opening:

Width: 7'8"

Height: 7'6"

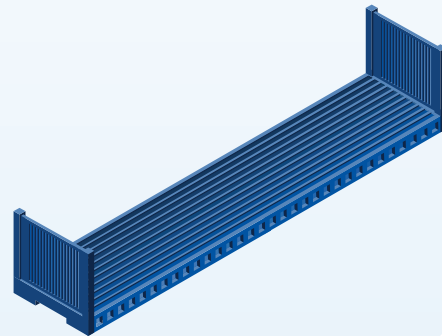

7. FLAT RACK

For transportation of over-width and heavy cargo.

TRIED AND TRUE BENEFITS

- Own equipment, including 20'DC, 40'DC, 40'HC, 40'PWHC, 45'PWHC, 20'OT, 40'OT, 20'FR, 40'FR
- Own containers available at various strategic locations
- Extensive network of depot facilities
- Broad knowledge and solid experience in one-way movements
- Ability to offer the right equipment depending on route, transport mode, cargo specifics and local regulations
- Possibility to create stocks (for projects)
- Competitive conditions for demurrage / detention
- Competitive slot agreements on feeder services

EXCELLENCE IN PERFORMANCE

- Cooperation with preferred and verified subcontractors
- Containers are delivered with valid CSC plate certification
- Containers are checked to ensure safe transportation by sea, rail or truck
- Possibility to arrange quick release of container equipment

RELIABLE SCHEDULES AND DELIVERY TIMES

Rhenus has an extensive network of depot facilities at all the main ports and other strategic locations in Europe, CIS, Turkey, China and Asia. This way, we guarantee on-time delivery to any given location.

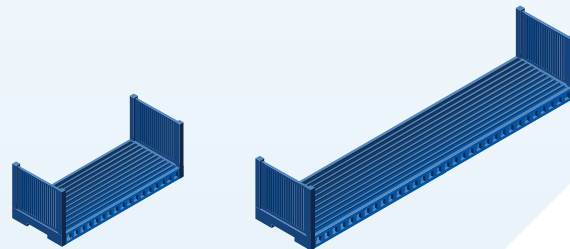

8. PLATFORM

For oversized and heavy cargo.

20' CONTAINER

// Length: 20'

// Width: 8'

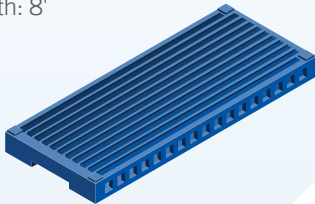

40' CONTAINER

// Length: 40'

// Width: 8'

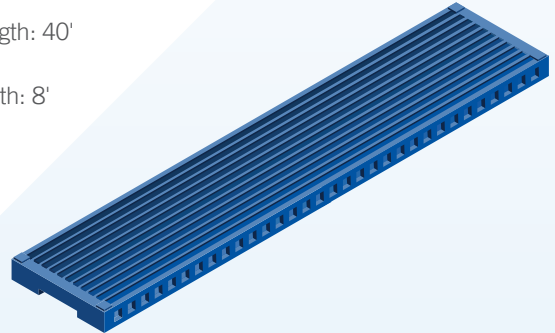

8. PLATFORM

For oversized and heavy cargo.

TRIED AND TRUE BENEFITS

- Own equipment, including 20'DC, 40'DC, 40'HC, 40'PWHC, 45'PWHC, 20'OT, 40'OT, 20'FR, 40'FR
- Own containers available at various strategic locations
- Extensive network of depot facilities
- Broad knowledge and solid experience in one-way movements
- Ability to offer the right equipment depending on route, transport mode, cargo specifics and local regulations
- Possibility to create stocks (for projects)
- Competitive conditions for demurrage / detention
- Competitive slot agreements on feeder services

EXCELLENCE IN PERFORMANCE

- Cooperation with preferred and verified subcontractors
- Containers are delivered with valid CSC plate certification
- Containers are checked to ensure safe transportation by sea, rail or truck
- Possibility to arrange quick release of container equipment

RELIABLE SCHEDULES AND DELIVERY TIMES

Rhenus has an extensive network of depot facilities at all the main ports and other strategic locations in Europe, CIS, Turkey, China and Asia. This way, we guarantee on-time delivery to any given location.

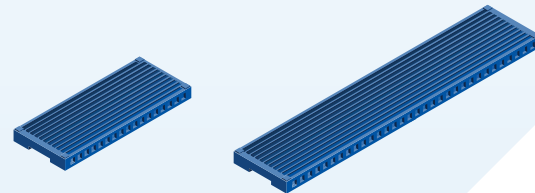

9. REFRIGERATED CONTAINER

For cooling, freezing or heating of foods or chemicals.

20' CONTAINER

Exterior:

Length: 20'

Width: 8'

Height: 8'6"

Interior:

Length: 19'6"

Width: 7'8"

Height: 7'10"

Door opening:

Width: 7'8"

Height: 7'6"

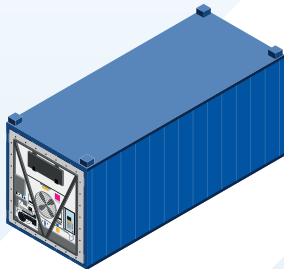

40' CONTAINER

Exterior:

Length: 40'

Width: 8'

Height: 8'6"

Interior:

Length: 39'7"

Width: 7'8"

Height: 7'10"

Door opening:

Width: 7'8"

Height: 7'7"

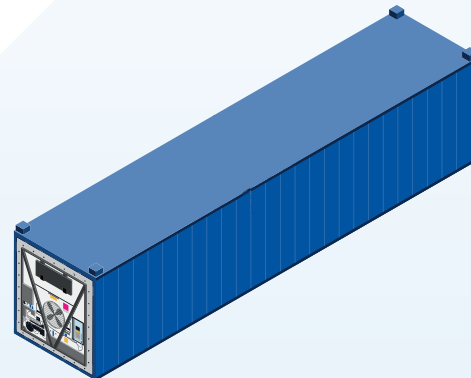

9. REFRIGERATED CONTAINER

For cooling, freezing or heating of foods or chemicals.

TRIED AND TRUE BENEFITS

- Own equipment, including 20'DC, 40'DC, 40'HC, 40'PWHC, 45'PWHC, 20'OT, 40'OT, 20'FR, 40'FR
- Own containers available at various strategic locations
- Extensive network of depot facilities
- Broad knowledge and solid experience in one-way movements
- Ability to offer the right equipment depending on route, transport mode, cargo specifics and local regulations
- Possibility to create stocks (for projects)
- Competitive conditions for demurrage / detention
- Competitive slot agreements on feeder services

EXCELLENCE IN PERFORMANCE

- Cooperation with preferred and verified subcontractors
- Containers are delivered with valid CSC plate certification
- Containers are checked to ensure safe transportation by sea, rail or truck
- Possibility to arrange quick release of container equipment

RELIABLE SCHEDULES AND DELIVERY TIMES

Rhenus has an extensive network of depot facilities at all the main ports and other strategic locations in Europe, CIS, Turkey, China and Asia. This way, we guarantee on-time delivery to any given location.

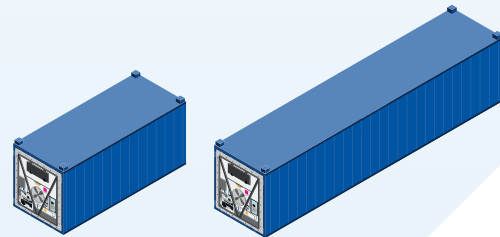

10. HIGH CUBE REFR. CONT.

For overheight or voluminous cargo requiring cooling or freezing.

Exterior:

Length: 40'

Width: 8'

Height: 9'6"

Interior:

Length: 38'2"

Width: 7'5"

Height: 8'5"

Door opening:

Width: 7'5"

Height: 8'5"

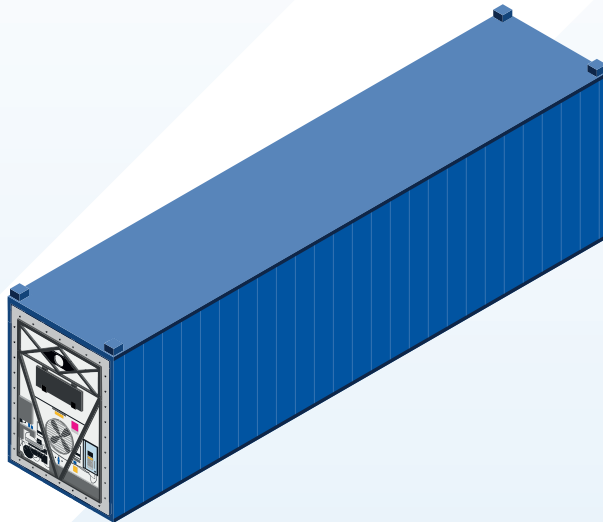

10. HIGH CUBE REFR. CONT.

For overheight or voluminous cargo requiring cooling or freezing.

TRIED AND TRUE BENEFITS

- Own equipment, including 20'DC, 40'DC, 40'HC, 40'PWHC, 45'PWHC, 20'OT, 40'OT, 20'FR, 40'FR
- Own containers available at various strategic locations
- Extensive network of depot facilities
- Broad knowledge and solid experience in one-way movements
- Ability to offer the right equipment depending on route, transport mode, cargo specifics and local regulations
- Possibility to create stocks (for projects)
- Competitive conditions for demurrage / detention
- Competitive slot agreements on feeder services

EXCELLENCE IN PERFORMANCE

- Cooperation with preferred and verified subcontractors
- Containers are delivered with valid CSC plate certification
- Containers are checked to ensure safe transportation by sea, rail or truck
- Possibility to arrange quick release of container equipment

RELIABLE SCHEDULES AND DELIVERY TIMES

Rhenus has an extensive network of depot facilities at all the main ports and other strategic locations in Europe, CIS, Turkey, China and Asia. This way, we guarantee on-time delivery to any given location.

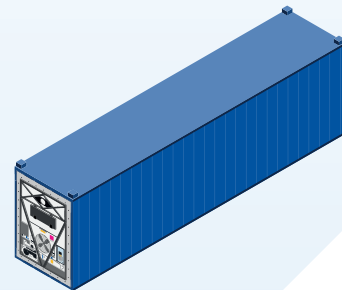

11. TANK CONTAINER

For transportation of liquid chemicals and food stuffs.

20' CONTAINER

Exterior:

Length: 20'

Width: 8'

Height: 8'6"

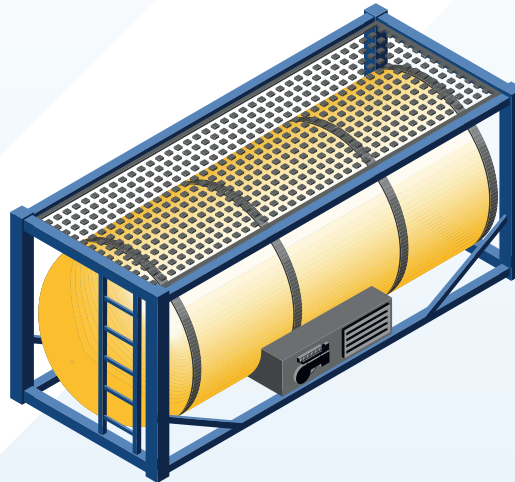

11. TANK CONTAINER

For transportation of liquid chemicals and food stuffs.

TRIED AND TRUE BENEFITS

- Own equipment, including 20'DC, 40'DC, 40'HC, 40'PWHC, 45'PWHC, 20'OT, 40'OT, 20'FR, 40'FR
- Own containers available at various strategic locations
- Extensive network of depot facilities
- Broad knowledge and solid experience in one-way movements
- Ability to offer the right equipment depending on route, transport mode, cargo specifics and local regulations
- Possibility to create stocks (for projects)
- Competitive conditions for demurrage / detention
- Competitive slot agreements on feeder services

EXCELLENCE IN PERFORMANCE

- Cooperation with preferred and verified subcontractors
- Containers are delivered with valid CSC plate certification
- Containers are checked to ensure safe transportation by sea, rail or truck
- Possibility to arrange quick release of container equipment

RELIABLE SCHEDULES AND DELIVERY TIMES

Rhenus has an extensive network of depot facilities at all the main ports and other strategic locations in Europe, CIS, Turkey, China and Asia. This way, we guarantee on-time delivery to any given location.

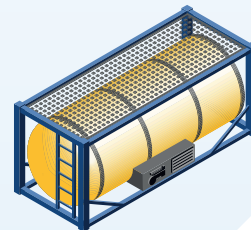

12. CONTACT

Rhenus Intermodal Systems NV

Noordersingel 21
2140 Antwerpen
Belgium

Marjolaine Van Gestel

Equipment Sales & Development

Phone: +3232245859

Mobile: +32496704856

Email: Marjolaine.Vangestel@be.rhenus.com

Web: www.rhenus.group